

TYPICAL TRAPEZE PIPE HANGER
DETAIL
N.T.S.

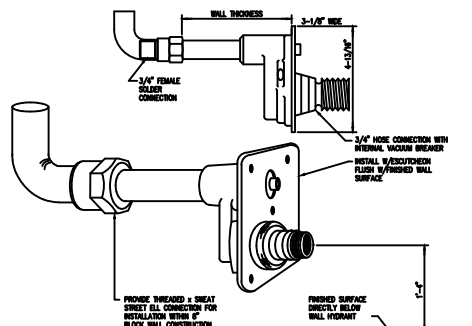

TYPICAL NON-FREEZE WALL HYDRANT
DETAIL
N.T.S.

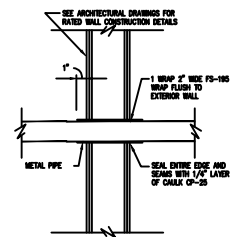

TYPICAL WALL TYPE FIRESTOP
DETAIL
N.T.S.

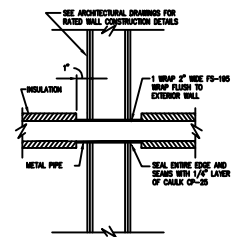

TYPICAL WALL TYPE FIRESTOP
DETAIL
N.T.S.

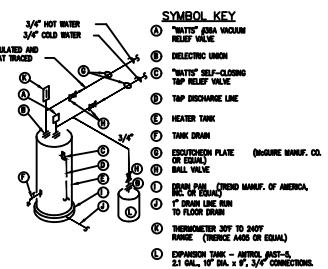

TYPICAL ELECTRIC WATER HEATER
PIPING SCHEMATIC
N.T.S.

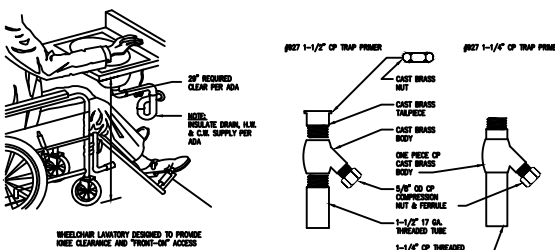

TYPICAL HANDICAPPED WALL
MOUNTED LAVATORY DETAIL
N.T.S.

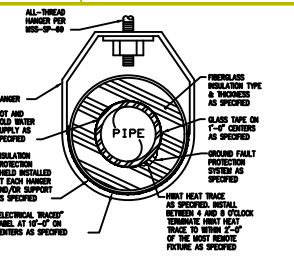

TYPICAL HEAT TRACE DETAIL
N.T.S.

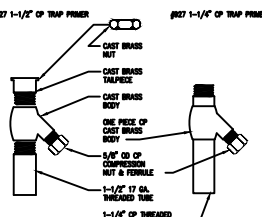

TYPICAL TRAP
PRIMER DETAIL
N.T.S.

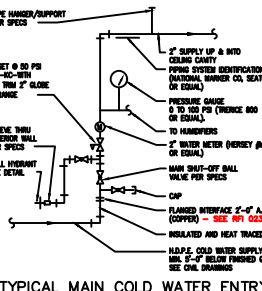

TYPICAL MAIN COLD WATER ENTRY
TO BUILDING DETAIL
N.T.S.

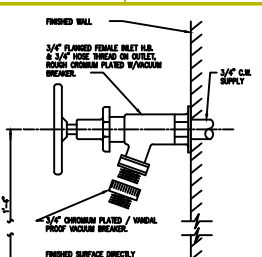

TYPICAL INTERIOR HOSE BIBB
DETAIL
N.T.S.



REVISION	DATE	BY	CHKD
1	08-21-97	L. H. HUNTER	
2	09-23-97	F. FARMER	
3	09-23-97	L. H. HUNTER	
4	09-23-97	F. FARMER	
5	09-23-97	L. H. HUNTER	
6	09-23-97	F. FARMER	
7	09-23-97	L. H. HUNTER	
8	09-23-97	F. FARMER	
9	09-23-97	L. H. HUNTER	
10	09-23-97	F. FARMER	
11	09-23-97	L. H. HUNTER	
12	09-23-97	F. FARMER	

BRPH ARCHITECTS • ENGINEERS, INC.
MELBOURNE / TALLAHASSEE, FLORIDA
KODIAK LAUNCH COMPLEX
NARROW CAPE, KODIAK ISLAND, ALASKA
PAYLOAD PROCESSING FACILITY
PLUMBING DETAILS
ALASKA AEROSPACE DEVELOPMENT CORPORATION
PROPRIETARY INFORMATION
DATE: 3-28-97
F. FARMER
L. HUNTER
DWG CODE: 300221000-1
PROJECT NO: 300221
SHEET: PP-5